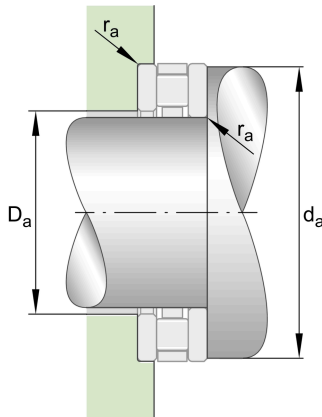
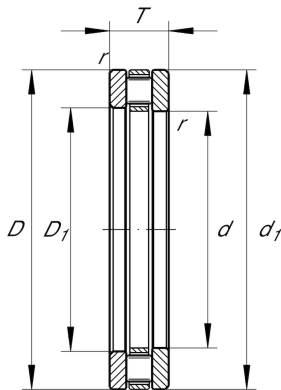
**81106-TV**

Axial cylindrical roller bearing

Schaeffler ID:
0002402810000Axial cylindrical roller bearings 811, single
direction, comprising K811, GS, WS

Technical information

**Main Dimensions & Performance Data**

d	30 mm	Bore diameter
D	47 mm	Outside diameter
T	11 mm	Height
C_a	35,500 N	Basic dynamic load rating, axial
C_{0a}	86,000 N	Basic static load rating, axial
C_{ua}	8,200 N	Fatigue load limit, axial
n_G	7,500 1/min	Limiting speed
n_{gr}	3,050 1/min	Reference speed
	58 g	Weight

Additional information

	K81106-TV	Axial roller and cage assembly
D_1	32 mm	Bore diameter housing washer
	GS81106	Housing Washer
d_1	47 mm	Rip diameter shaft washer
	WS81106	Shaft washer
	LS3047	Track Washer
r_{min}	0.6 mm	Minimum chamfer dimension

Mounting dimensions

$d_{a min}$	46 mm	Minimum diameter shaft shoulder
$D_{a max}$	31 mm	Maximum diameter of housing shoulder
$r_{a max}$	0.6 mm	Maximum recess radius

Temperature range

T_{min}	120 °C	Operating temperature min.
T_{max}	-30 °C	Operating temperature max.